

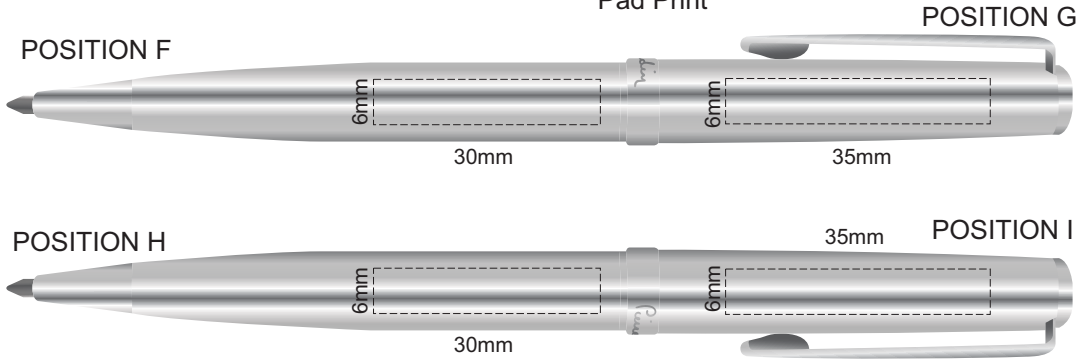

100% of Actual Size  
Pad Print

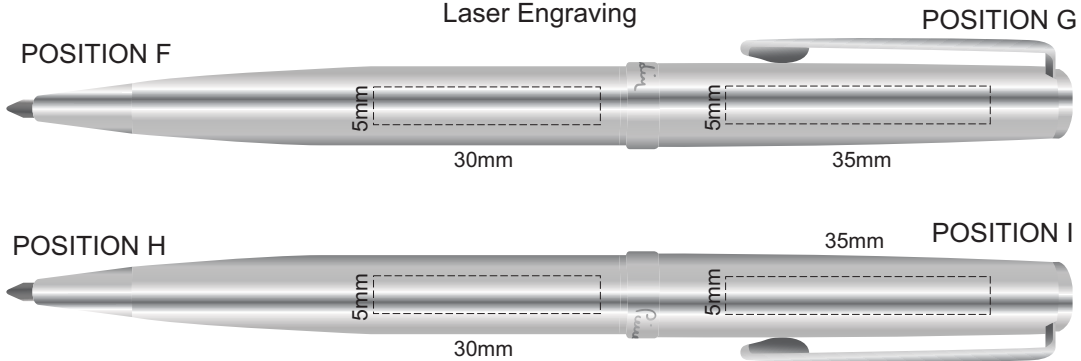

100% of Actual Size  
Laser Engraving



Chrome engraves to a Silver Natural Etch

100% of Actual Size  
Pad Print

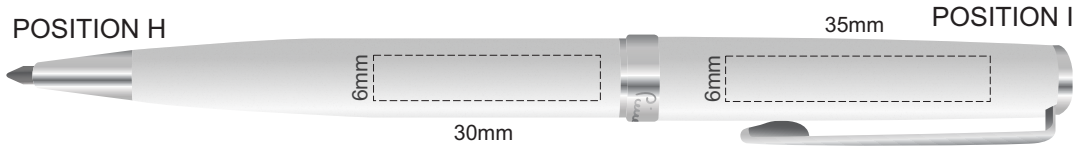
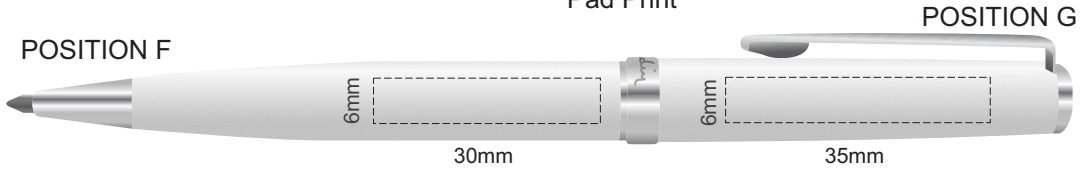

100% of Actual Size  
Laser Engraving

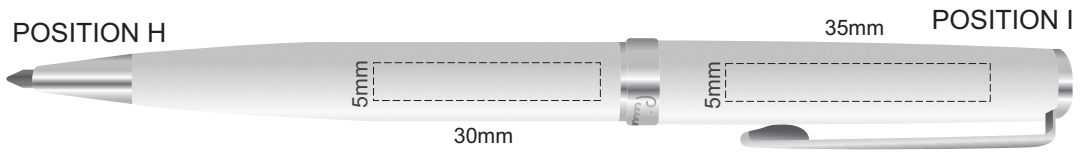
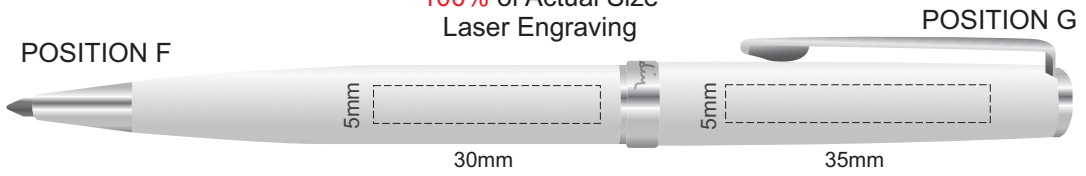

■ Matt Silver engraves to a Silver Natural Etch



100% of Actual Size  
Thermo Debossing  
Thermo Debossing XL

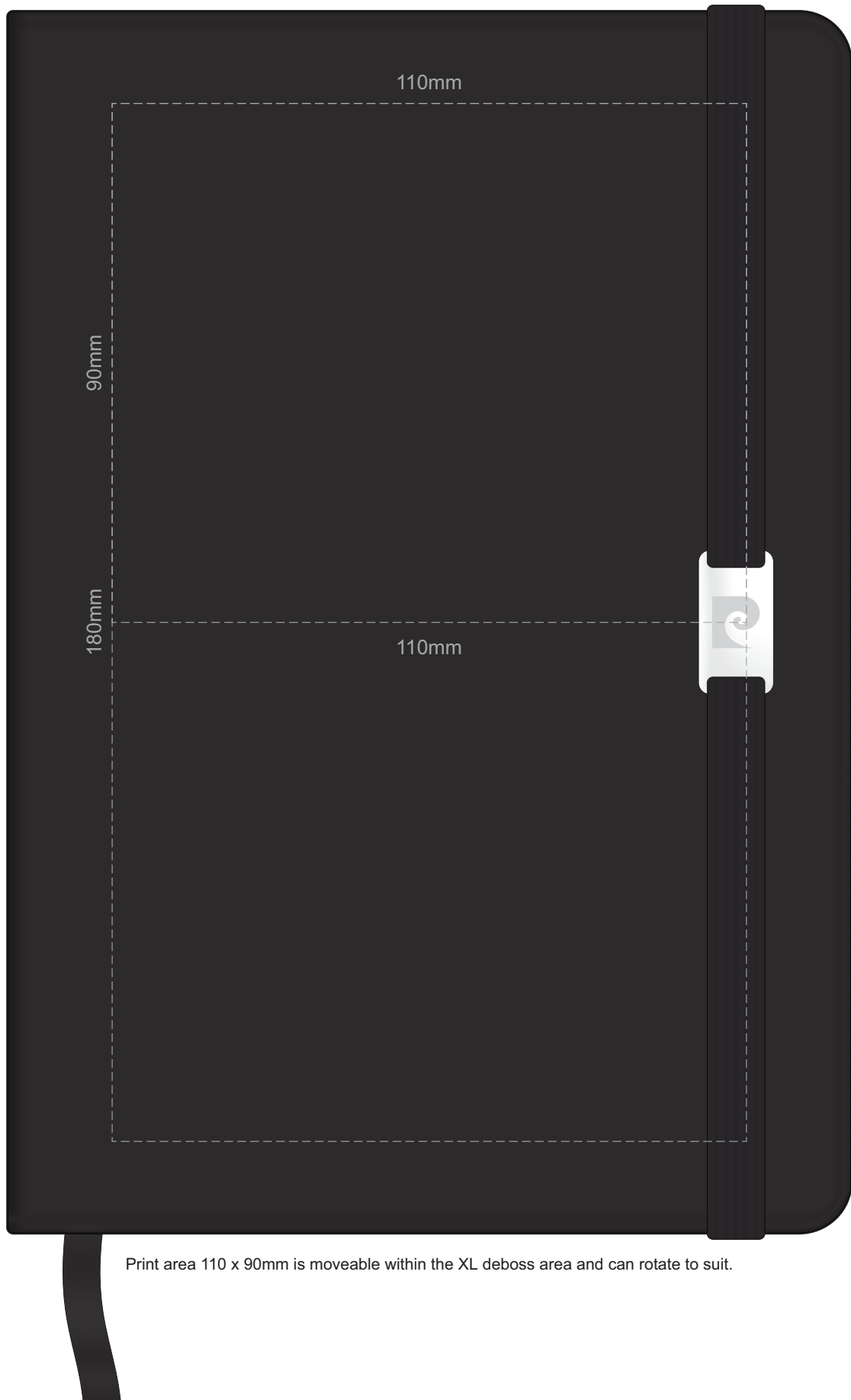

Print area 110 x 90mm is moveable within the XL deboss area and can rotate to suit.

100% of Actual Size  
Thermo Debossing (back)  
Thermo Debossing XL (back)

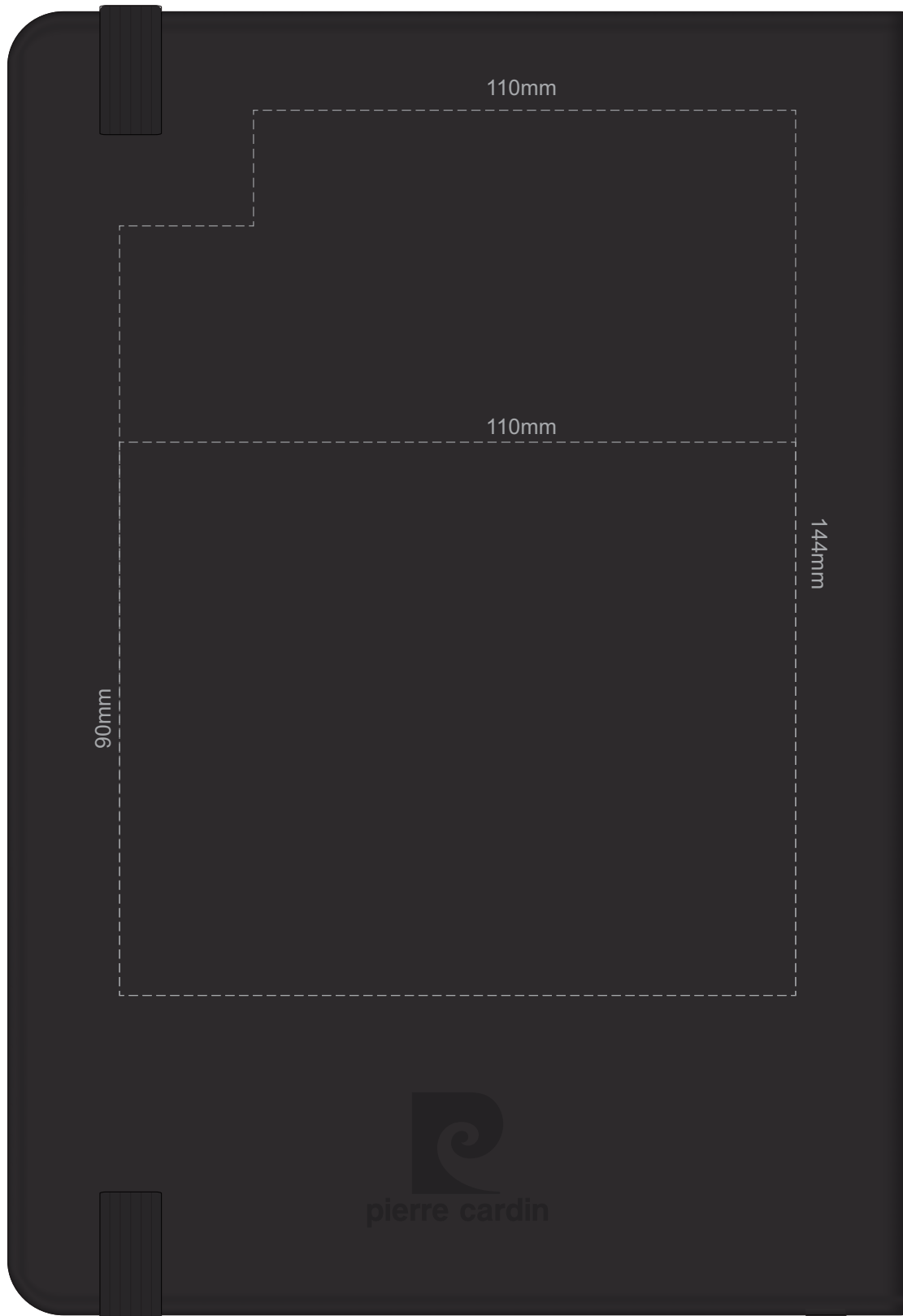

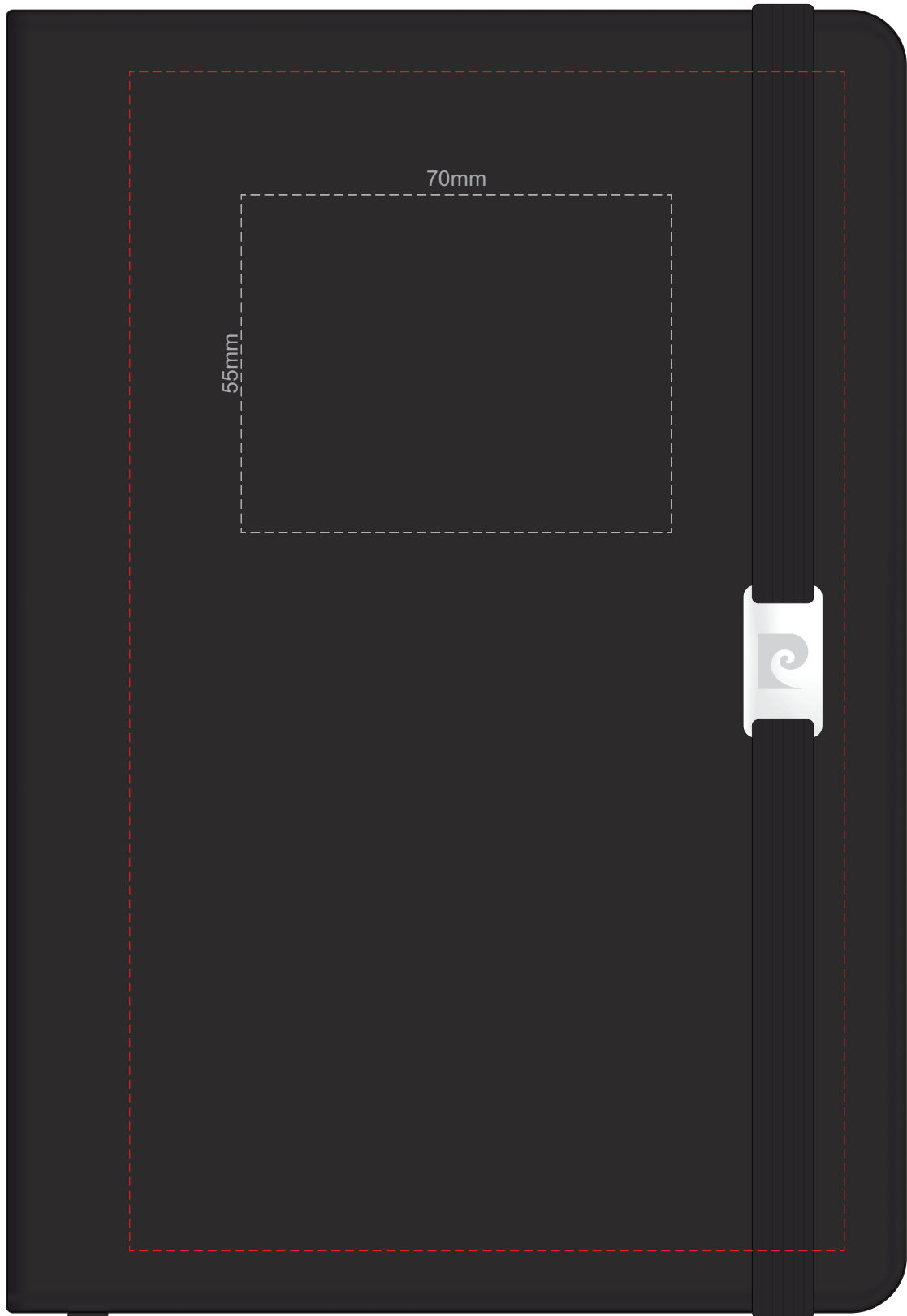

Print area 110 x 90mm is moveable within the XL deboss area and can rotate to suit.

100% of Actual Size  
Foil Printing Front Cover  
FRONT ONLY



Please note: Print area 70mm x 55mm is **moveable within the red dotted area**, the print area cannot be rotated.  
The printing will inherit the texture of the substrate which may affect the legibility of small text or appearance of fine detail.

-  Copper Foil Print Colour
-  Silver Foil Print Colour
-  Gold Foil Print Colour



65% of Actual Size  
Digital Print - Belly Band Template

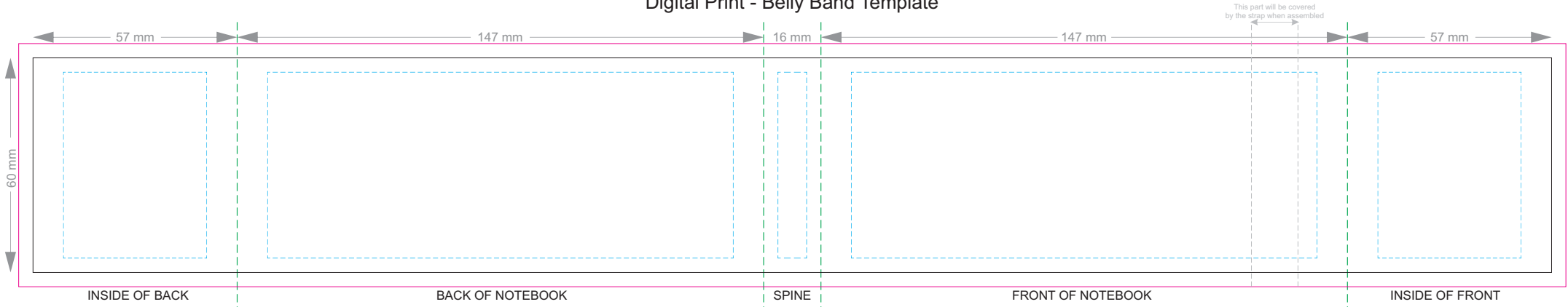

Artwork will be printed directly onto the product via CMYK printing (no white), colours will not be vibrant due to white ink not being available for this process

Green Line = Fold Lines when assembled on notebook

Blue Line = The SIGNIFICANT PRINT AREA

(Keep all critical images & text within this box)

Black Line = Maximum print area

Pink Line = Bleed off to here

25% of Actual Size

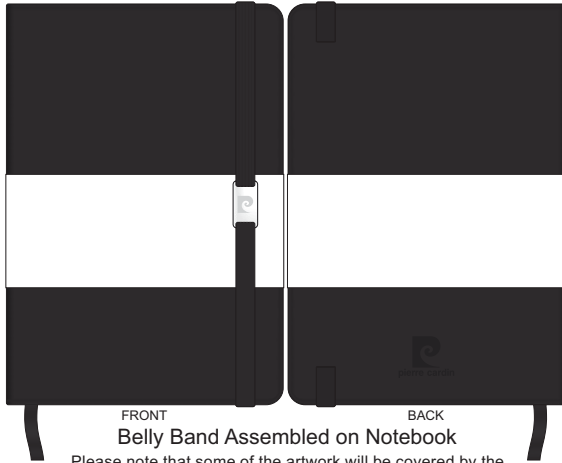

FRONT BACK  
Belly Band Assembled on Notebook

Please note that some of the artwork will be covered by the notebook closure strap when assembled.